

Electric Fogger Owner's Manual

**Model:
F-8, F-16**

(115 V~60Hz)

Read and save these instructions



Intertek

www.xpower.com | 1-(855)-855-8868 | info@xpower.com

Index: NA-1-30
Edition: 2.0.Final

Safety Instructions

WARNING: READ AND SAVE THESE INSTRUCTIONS BEFORE USING THIS PRODUCT.

When using electrical appliances, especially when children or animals are present, basic safety precautions should always be followed to reduce the risk of fire, electric shock, and personal injury, including, but not limited to the following:

- **DO NOT** attempt to perform any service or maintenance not outlined in instruction manual.
- **WARNING:** To reduce the risk of electric shock – Use indoors only. **DO NOT** use outdoors.
- **WARNING:** This machine is not intended for use by children. Adult assembly and operation required. To reduce the risk of injury, close supervision is necessary when an appliance is used near children.
- **DO NOT** use as a toy.
- **DO NOT** leave appliance when plugged in. Unplug from outlet when not in use and before servicing.
- **DO NOT** use extension cords with machine.
- **DO NOT** unplug unit by pulling on cord, to unplug, grasp the plug, not the cord.
- **WARNING:** Never use a machine with a damaged cord or plug, or after the machine malfunctions or is dropped, damaged. Return to an authorized service center for service, examination, repair, or electrical or mechanical adjustment.
- To disconnect, turn all controls to the off (“O”) position, then remove plug from outlet.
- **DO NOT** pull or carry by cord, use cord as a handle, close a door on cord, or pull cord around sharp edges or corners. **DO NOT** run appliance over cord. Keep cord away from heated surfaces.
- **DO NOT** handle plug or appliance with wet hands.
- Use extra care when cleaning on stairs.
- **DANGER: DO NOT** expose the machine to rain or water.
- **DO NOT** use or store machine where it can fall or be pulled into tub or sink or standing water. If machine falls into water, unplug it, **DO NOT** reach into the water. Keep units out of baths and **DO NOT** operate on a wet floor, or wet surface.
- **WARNING: DO NOT** allow any material to clog or block air intakes as this may cause units to overheat and result in a fire or electrical hazard. **DO NOT** direct the air / fogging outlet to human beings or living animals.
- **WARNING: DO NOT** expose this machine to extreme temperature.
- (For Model F-16) Connect to a properly grounded outlet only. See Grounding Instructions.
- **WARNING:** Filling these types of solution / liquid into the solution tank, may cause safety hazards, corrosive damages to the machine or blockage of the fogging system.
 - (1) Strong acids, strong bases or other corrosive liquids
 - (2) Alcohol, or flammable or explosive liquids

- (3) Oil, or other organic oils
- (4) Liquids containing particles or sediments
- (5) Detergents

Grounding Instructions (For Model F-16)

This appliance must be grounded. In the event of malfunction or breakdown, grounding provides a path of least resistance for electric current to reduce the risk of electric shock. This appliance is equipped with a cord having an equipment-grounding conductor and a grounding plug. The plug must be plugged into an appropriate outlet that is properly installed and grounded in accordance with all local codes and ordinances.

A qualified electrician should be consulted if there is any doubt as to whether an outlet box is properly grounded.

DANGER: Improper connection of the equipment-grounding conductor can result in a risk of electric shock. The conductor with insulation having an outer surface that is green with or without yellow stripes is the equipment-grounding conductor. If repair or replacement of the cord or plug is necessary, do not connect the equipment-grounding conductor to a live terminal. Check with a qualified electrician or service professional if the grounding instructions are not completely understood, or if in doubt as to whether the appliance is properly grounded. Do not modify the plug provided with the appliance – if it will not fit the outlet, have a proper outlet installed by a qualified electrician.

This appliance is for use on a nominal 115V circuit (NEMA 5-15R), and has a grounding plug (NEMA 5-15P) as illustrated below. Make sure that the appliance is connected to an outlet having the same configuration as the plug. No adapter should be used with this appliance.

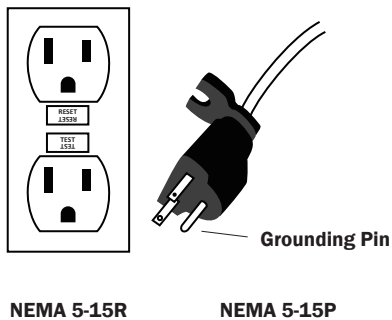

Electric Fogger Introduction

- The Electric Fogger produces ULV fine mist with high velocity airflow helping the distribution of different liquids to the indoor space and surfaces for various applications.

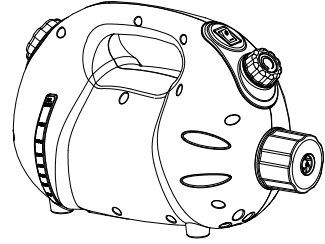

Items Included

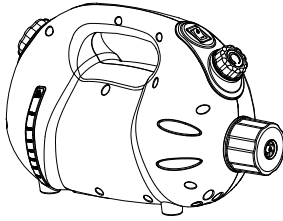

- Electric Fogger x 1



- Owner's Manual x 1



- Fogging Outlet x 1

* The fogging outlet might be sold separately. Some of the models may already include extra fogging outlets.

Parts Description

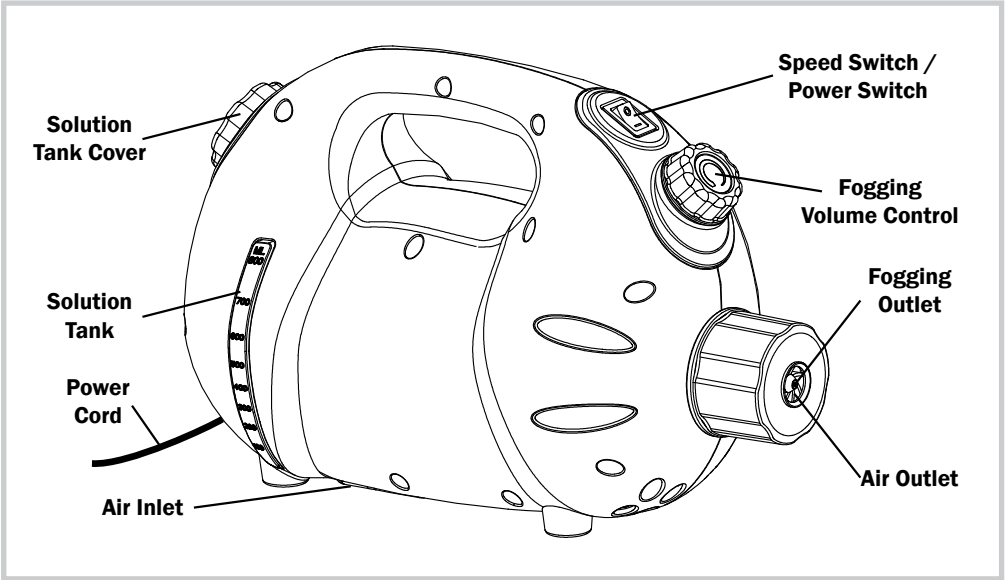

Operation Guide

Change the Fogging Outlet*

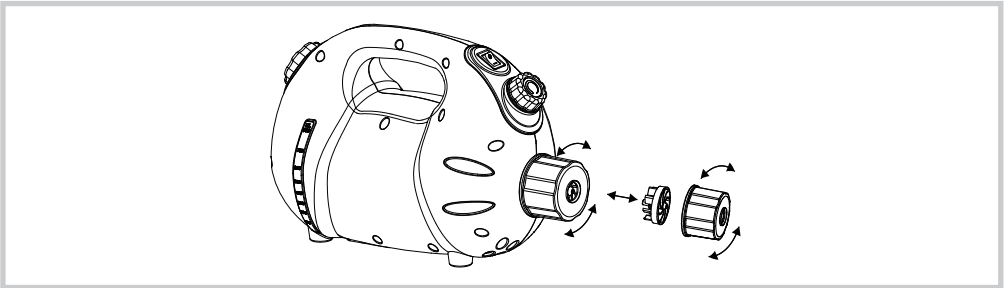

- Turn counterclockwise to uninstall the fogging outlet cover and take out the fogging outlet. Apply the new fogging outlet and reinstall the fogging outlet cover.
- The size of the fogging outlet varies and produces different fogging effects. (See Page 11: Technical Specifications)

* The fogging outlet might be sold separately. Some of the models may already include extra fogging outlets.

Control Panel



Fogging Volume Control

- Turn counterclockwise to high-en the fogging volume. Turn clockwise to low-en the fogging volume.
- When at the lowest position, no liquid will coming out.



Speed Switch (For model F-16 only)

- Switch to “**O**” setting to turn the machine OFF.
- Switch to other settings to turn the machine on. “**I**”/“**II**” means the lower/higher speed setting.

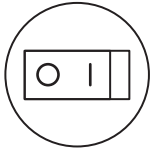

Power Switch (For model F-8 only)

- Switch to “**O**” setting to turn the machine OFF. Switch to “**I**” setting to turn the machine ON.

Start Your Job

Filling the Solution Tank

- **IMPORTANT:** Always turn the fogging volume control to the lowest setting and disconnect the machine from the power source before filling the solution tank.
- Turn counterclockwise to open the solution tank cover, and fill designated solution or liquid into the solution tank. Do not exceed the maximum capacity of the solution tank. (See Page 8: *Fogging System Maintenance*) Close the solution tank cover.
- **WARNING:** Filling these types of solution / liquid into the solution tank may cause safety hazards, corrosive damages to the machine or blockage of the fogging system:
 - (1) Strong acids, strong bases or other corrosive liquids
 - (2) Alcohol, or flammable or explosive liquids
 - (3) Oil, or other organic oils
 - (4) Liquids containing particles or sediments
 - (5) Detergents
- **IMPORTANT:** If you intend to fill the solution of the types mentioned above, please contact the manufacturer of the solution for usage reference and proper methods of cleaning. (See Page 8: *Fogging System Maintenance*)

Start Your Job (Continued)

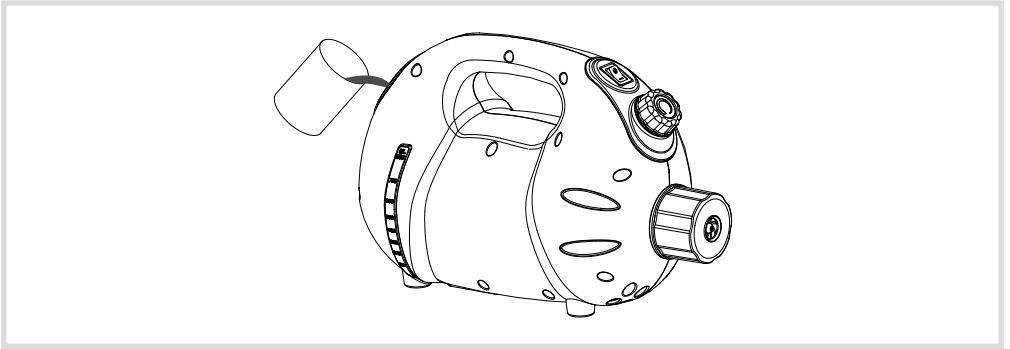

Select a Power Source with a Proper Location

- Check the throw distance of the machine. (See Page 10: Technical Specifications)
- Please find a power source with a proper location where the fogging droplets can reach designated objects.

Start Fogging

- Connect the machine to power source.
- **IMPORTANT:** Make sure the fogging volume control is on the lowest setting before turning the power on.
- Turn on the machine and set to designated speed.
- Turn the fogging volume control counterclockwise to set designated fogging volume.

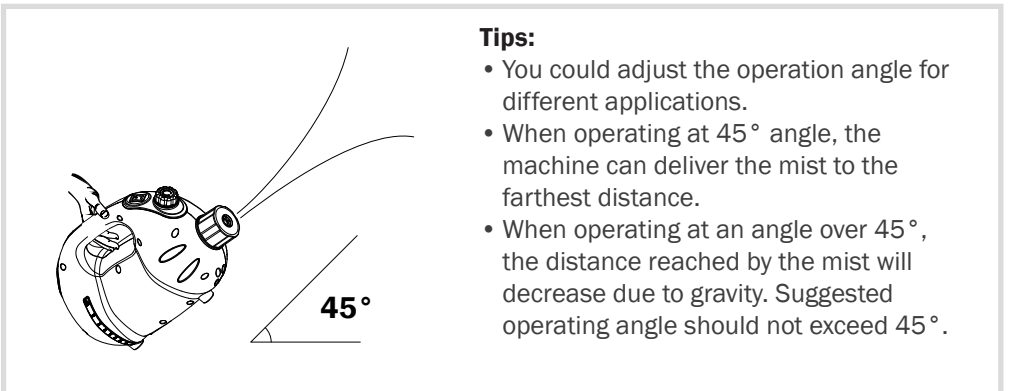

Tips:

- You could adjust the operation angle for different applications.
- When operating at 45° angle, the machine can deliver the mist to the farthest distance.
- When operating at an angle over 45°, the distance reached by the mist will decrease due to gravity. Suggested operating angle should not exceed 45°.

Turn off the Machine

- Turn the fogging volume control clockwise to the lowest setting.
- Turn off the machine and disconnect the machine from its power source.
- **IMPORTANT:** Discard or use up the liquids in the solution tank. If you are not able to use up the liquids, transfer the liquids into a safe container, or follow the disposal instructions of the liquids if applicable.

Start Your Job (Continued)

- Use proper methods of cleaning for the solution tank. (See Page 8: Fogging System Maintenance)

User Maintenance and Servicing Instructions

Frequent maintenance is recommended on this appliance. Failure to follow the maintenance instructions may cause failure of the appliance and void the warranty. Always disconnect the machine from the power source before any maintenance or servicing.

Cleaning the Surface

- Use a damp cloth to wipe the surface of the housing. Do not clean the unit with water directly.
- Remove dirt or any other objects that could block the air inlet, air outlet or the fogging outlet.

Storage

- When not in use, make sure no liquids are left in the solution tank.
- Store the appliance in a dry and cool indoor place. Make sure it's out of reach of children.

Fogging System Maintenance

Cleaning the Solution Tank

- Turn the fogging volume control to the lowest setting.
- Fill the solution tank with cold water to half of maximum capacity, close the solution tank and shake the machine a few times. Then open the solution tank and discard the water inside. Repeat the steps above 2 times.
- Check if the solution tank is clean. If not, please repeat the steps above until tank is fully cleaned.

Cleaning the Liquid Conduit and Fogging Outlet

- Turn the fogging volume control to the lowest setting.
- Fill the solution tank with cold water to half of maximum capacity and close the solution tank.
- Connect to power source.
- Turn on the machine and turn the fogging volume control to the highest setting.
- Keep the machine working for 3 minutes. Turn the fogging volume control to the lowest setting, turn off the machine and disconnect the power source.
- Open the solution tank and discard the water inside. Close the solution tank. Wipe the water on the machine surface and the fogging outlet.

Selection Suggestions of Cleaning Agent

- It's recommended to use **COLD WATER ONLY** to clean the fogging system.

Fogging System Maintenance (Continued)

- You might follow the cleaning and disposal instructions of the liquids used for fogging if applicable.
- **WARNING:** Filling these types of solution / liquid into the solution tank for cleaning, may cause safety hazards, corrosive damages to the machine or blockage of the fogging system.
 - (1) Strong acids, strong bases or other corrosive liquids
 - (2) Alcohol, or flammable or explosive liquids
 - (3) Oil, or other organic oils
 - (4) Liquids containing particles or sediments
 - (5) Detergents

Troubleshooting Guide

PROBLEM	POSSIBLE CAUSE	SOLUTION
Unit does not start	No electricity.	Check for power supply.
	The power cord is not properly plugged in.	Remove and reconnect the power cord.
Unit runs but the speed / noise is abnormal	Air inlet, air outlet or fogging outlet is blocked.	Remove blockage. (See <i>Page 8: Fogging System Maintenance</i>)
Unit runs but no liquid or fog is coming out	No liquid in the solution tank.	Fill up the solution tank with designated liquid.
	The solution tank is not enclosed.	Close the solution tank and fasten the solution tank cover.
	The fogging volume control is turned to the lowest setting.	Turn the fogging volume control to a higher setting.
	The fogging outlet is blocked.	Remove blockage. Clean the fogging outlet and the liquid conduit. (See <i>Page 8: Fogging System Maintenance</i>)
	The liquid conduit is blocked.	

Technical Specification

MODEL NUMBER	F-8	F-16
Voltage/Frequency	115 V~60 Hz	
Amperage	3.0 A	4.5 A
Solution Tank Capacity	800 ml	1600 ml
Airflow Speed Settings	1 Speed	2 Speeds
Cord Length	20 ft. / 6.1 m	25 ft. / 7.6 m
Housing	PP	
Unit Dimension (L) x (W) x (H)	12.1 x 6.4 x 7.8 in. / 30.7 16.2 x 19.7 cm	14.6 x 6.8 x 8.3 in. / 37.1 x 17.2 x 21.0 cm
Unit Weight	4.9 lbs. /2.2 kg	6.0 lbs. /2.73 kg
Safety Certification	ETL / C-ETL	

If your product(s) is not listed above, please visit www.xpower.com for more information.

Fogging Outlet Specification

	Fogging Outlet	Max Fogging Volume	Max Throw Distance
F-8	0.9 mm (Marked 1)	100 ml / min	33 ft. / 10.0 m
	1.5 mm (Marked 2)	200 ml / min	34 ft. / 10.5 m
F-16	2.0 mm (Marked 3)	250 ml / min	38 ft. / 11.5 m
	3.0 mm (Marked 4)	350 ml / min	39 ft. / 12.0 m

XPOWER Limited Warranty (USA)

1 YEAR LIMITED WARRANTY

XPOWER-branded products purchased in the U.S. from authorized distributors include a 1-year limited warranty. Contact XPOWER to confirm warranty information about your product(s).

This limited warranty covers defects in materials and workmanship in your XPOWER-branded products, purchased in the **U.S. ONLY**. Local warranty policy (if any) in your country will cover products purchased outside the U.S.

Items mentioned but not limited to below are not covered by warranty:

- (1) Power cord, filters or any other components considered as a “consumable parts” by XPOWER.
- (2) Normal wear and tear.
- (3) Problems that result, directly or indirectly, at XPOWER’s sole discretion, from:
 - (3.1) External causes such as accident, abuse, misuse or problems with electrical power supply.
 - (3.2) Disassembling, servicing or modification not authorized by XPOWER.
 - (3.3) Usage that is not accordant with product instructions stated in Owner’s Manual.
 - (3.4) Failure to follow the product instructions or lack of necessary maintenance stated in Owner’s Manual.



IMPORTANT:

- (1) Please finish the on-line warranty registration before usage. Visit www.xpower.com/service-support/warranty-registration.
- (2) This Limited Warranty applies with its own timeliness. Contact XPOWER or visit www.xpower.com for more information.

Before contacting XPOWER, please try one or more of the following:

- (1) Consult this Owner’s Manual and follow the instructions of troubleshooting guide.
- (2) Access www.xpower.com for more advice and information that could be helpful to address your problems.

If you need additional assistance from XPOWER, please:

- (1) Email info@xpower.com.
- (2) Call XPOWER U.S. Customer Service Department at **855-855-8868** or other numbers provided on www.xpower.com.
- (3) Visit XPOWER U.S. Head Office at 668 S. 6th Ave., City of Industry, CA 91746 or the most current address provided on www.xpower.com.

Please also have your original proof of purchase and the serial number(s) of your product(s) ready when you contact XPOWER.

If you are instructed to return the unit for service or replacement, please:

- (1) Request a RMA (Return-Merchandise-Authorization) number.
- (2) Use the original or an equivalent packaging, prepay shipping charges at your own expense to the address provided by XPOWER, with the RMA number on the shipping label or the packaging.
- (3) Include all the original parts and components.
- (4)

XPOWER will inspect, assess and advise the repairs needed and applicable cost, if any. For products under warranty, we will pay to ship the repaired or replaced product(s) to you if you use an address within the Contiguous United States. Otherwise, we will ship the product(s) to you at your own expense.



XPOWER Manufacture, INC.

668 S. 6th Ave.,

City of Industry, CA 91746 USA

www.xpower.com | 1-(855)-855-8868 | info@xpower.com

Read and save these instructions